

# COMPOSITE MANHOLE COVER

GRP / FIBERGLASS / COMPOSITE MANHOLE PRODUCTS





ESSELAR Composite Manhole Products, a green innovation from the production house of Smithline Reinforced Composites FZ-LLC, an industrial expert in manufacturing of GRP, GRV, GRE pipes and fittings, tanks, pressure vessels, PIR/ PUR / Phenolic insulation foams etc.

Smithline has:

- Quality certifications to standards ISO 9001:2015, ISO14001:2015, ISO 45001:2018
- API monogram licenses to standards API15LR and API 15HR
- BSI Kitemark license to standard ASTM D3517
- WRAS approvals for use of GRP pipes, GRV pipes, GRE pipes in potable water lines.

Though our primary business is GRP piping sector, we invested in developing the GRP manhole covers, frames and chambers as the industry is seeking to utilize the unique advantages of GRP over traditional materials in manholes sector. We are manufacturing GRP manhole covers & frames and GRP manhole chambers from 2012 onwards and our products are widely accepted by all government authorities in UAE, Oman, Qatar, Bahrain and Saudi Arabia. Currently our GRP manholes are installed in the projects of Etisalat UAE, RAKWA & Dubai Aluminium.

Comparing with steel, GRP material has got distinct advantages like corrosion resistant to almost all chemicals, weather resistance, Zero maintenance, anti-theft, durable, light weight, easy customization in size and color. Engineered without compromise and achieving reduced carbon footprint in Production, the life cycle cost is also 50% of steel and other materials. GRP covers are preferable for wifi metering due to its low interference to radio signals. Smithline manhole chambers are used in storm water service, Sewerage service, telecommunication cable intercepts and junction boxes.



UNITED ARAB EMIRATES  
MINISTRY OF INFRASTRUCTURE  
DEVELOPMENT

Approved Supplier



استدامة  
estidama

Pearl Building Rating System  
Complying Products



JEC Innovation Award  
Winner, 2013



Composite Manhole  
Assessment Report

Scan me

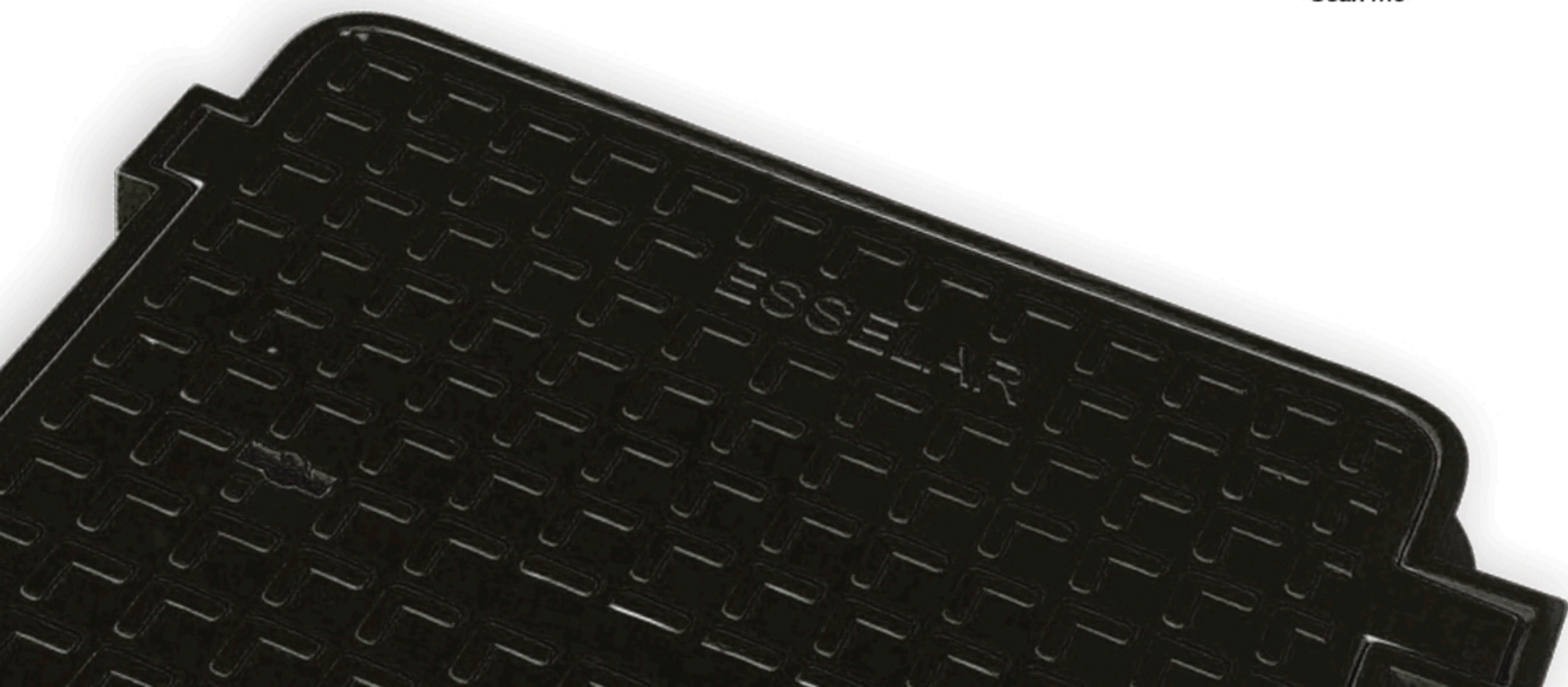

# Advantages of Composite GRP Manhole covers

GRP MANHOLE COVERS ARE  
**50% LESS** CARBON FOOTPRINT  
WHEN COMPARED WITH SAME SIZE,  
CLASS OF THAT STEEL MANHOLE COVERS.



- **Environmental friendly. Low carbon foot print. [Clean earth, Green Economy].**

Two key features supporting manhole covers in composite material compared to cast iron:

1. Lower energy consumption, thanks to the temperature for the manufacture (70°C for Esselar manhole cover compared with 1200°C for cast iron manhole cover) and
2. Lower transport impact, thanks to the reduced weight (it is possible to load a quantity of Esselar manhole covers three times higher than cast iron manhole covers).



- **Heavy duty and corrosion free.**

Esselar manhole covers are resistant to chemicals and are not subject to rust and corrosion caused by constant exposure to atmospheric agents. It is unaffected by underground gases and most chemicals. For this reason it never needs to be re-painted, and products are particularly suitable in areas with flammable liquids such as fuel filling stations and storage plants, significantly reducing the risk of ignition from sparks over ferrous materials.



- **Various classes of manhole covers are available as per International Standard.**

We have BSEN 124 D 400 load rated manhole covers for use in heavy traffic, diesel lanes, truck stops or bus depots and expressways. Then we have BSEN 124 C 250 medium duty covers for use in areas with normal traffic and car parking area. BSEN 124 B 125 load rated covers are suitable for use in pedestrian and walkways. Finally we have A15 (1.5tonne) suitable for surface boxes and protective covers available on request.



- **Minimum interference to the radio frequencies.**

It is the best solution in case of underground antenna applications like automated water meter reading, sewage monitoring systems, etc. due to low interference towards modern communication devices.



- **Low noise pollution.**

Composites have lower density than cast iron. It deadens the noise and disturbance caused by vehicles driving over installed covers.



- **Eliminates risk of theft due to no scrap/resale value.**

The value of scrap iron is rising and the number of thefts is impacting on costs to public authorities and service companies. Besides the economic impact caused by the theft of products, there is also the risk of serious accidents and injuries caused by dangerous openings on the road.



- **Lightweight and Easy to handle.**

Our manhole covers are 3 Times lighter than steel.

- It is available in various shapes Round, square and rectangular.
- Optional Watertight gaskets available with proven performance under load.
- Anti-slip surface (various patterns available).
- Monolithic structure eliminates delaminating.
- Available in any color(standard pallet available) – UV stable so will not flake or crack.
- Manufacturing facility ISO 9001: 2015, ISO 14001:2015, ISO 18001:2007 accredited.
- Excellent insulator against heat.

## NEED FOR A NEW MATERIAL?

- Manhole cover theft, the phenomenon of DI/cast Iron manhole covers being stolen, usually for resale as scrap.
- This is an alarming expensive concern to municipalities, and a dangerous mishap to their residents.

## MANUFACTURING PROCESS

- Glass Reinforced plastic is made up of polyester resin plus glass fiber.
- Using contact molded process (hand lay-up), glass fiber reinforcements are applied on to and wetted with Vinyl-ester or Poly-ester resin.
- Multiple layers are applied till to required thick/dimensions. Then it is allowed to cure.
- After curing, Product is de-molded and finishing work is done.

**600 x 600**

## SQUARE TYPE MANHOLE COVER AND FRAME



Product code	: <b>QUADRON D60</b>
Available classes	: C250, D400
Clear opening (mm)	: 600 x 600
Frame size (end to end)	: 790 x 790
Number of covers	: 1
Frame height	: 100
Hinges (optional)	: YES
Locking (optional)	: YES
Single seal gasket (optional)	: YES
Water tight sealing plate (optional)	: YES

**600 x 600**

## SQUARE TYPE MANHOLE COVER AND FRAME



Product code	: <b>QUADRON B60</b>
Available classes	: B125
Clear opening (mm)	: 600 x 600
Frame size (end to end)	: 790 x 790
Number of covers	: 1
Frame height	: 70
Hinges (optional)	: NO
Locking (optional)	: YES
Single seal gasket (optional)	: YES
Water tight sealing plate (optional)	: YES

**450 x 450**

## SQUARE TYPE MANHOLE COVER AND FRAME



Product code	: <b>QUADRON C45</b>
Available classes	: C250
Clear opening (mm)	: 450 x 450
Frame size (end to end)	: 640 x 640
Number of covers	: 1
Frame height	: 100
Hinges (optional)	: NO
Locking (optional)	: YES
Single seal gasket (optional)	: NO
Water tight sealing plate (optional)	: YES

**600 x 600**

**SQUARE TYPE MANHOLE COVER AND FRAME**



Product code	: TEL590 CW1
Available classes	: 15 TONNES
Clear opening (mm)	: 900 x 445
Frame size (end to end)	: 1046 x 641
Number of covers	: 1
Frame height	: 100
Hinges (optional)	: YES
Locking (optional)	: YES
Single seal gasket (optional)	: NO
Water tight sealing plate (optional)	: YES

**300 x 300**

**SQUARE TYPE MANHOLE COVER AND FRAME**



Product code	: QUADRON B30
Available classes	: B125, D400
Clear opening (mm)	: 300 x 300
Frame size (end to end)	: 490 x 490
Number of covers	: 1
Frame height	: 70
Hinges (optional)	: NO
Locking (optional)	: YES
Single seal gasket (optional)	: NO
Water tight sealing plate (optional)	: YES

**1000 x 1000**

**SQUARE TYPE MANHOLE COVER AND FRAME**



Product code	: QUADRON D100
Available classes	: B125, C250, D400
Clear opening (mm)	: 1000 x 1000
Frame size (end to end)	: 1190 x 1190
Number of covers	: 1
Frame Height	: 100
Hinges (optional)	: NO
Locking (optional)	: YES
Single seal gasket (optional)	: YES
Water tight sealing plate (optional)	: YES

**750 x 600**

**RECTANGULAR TYPE MANHOLE COVER AND FRAME  
APPROVED BY RAS AL KHAIMAH WATER AUTHORITY**



Product code	: TETRON D7560
Available classes	: C250, D400
Clear opening (mm)	: 750 x 600
Frame size (end to end)	: 940 x 790
Number of covers	: 1
Frame height	: 100
Hinges (optional)	: YES
Locking (optional)	: YES
Single seal gasket (optional)	: YES
Water tight sealing plate (optional)	: YES

**705 x 655**

**RECTANGULAR TYPE MANHOLE COVER AND FRAME  
APPROVED BY ABUDHABI MUNICIPALITY**



Product code	: TETRON D7065
Available classes	: C250, D400
Clear opening (mm)	: 705 x 655
Frame size (end to end)	: 875 x 825
Number of covers	: 1
Frame height	: 100
Hinges (optional)	: NO
Locking (optional)	: NO
Single seal gasket (optional)	: NO
Water tight sealing plate (optional)	: NO

**450 x 450**

**RECTANGULAR TYPE MANHOLE COVER ONLY  
SUITABLE FOR EXISTING ETISALAT DI FRAMES**

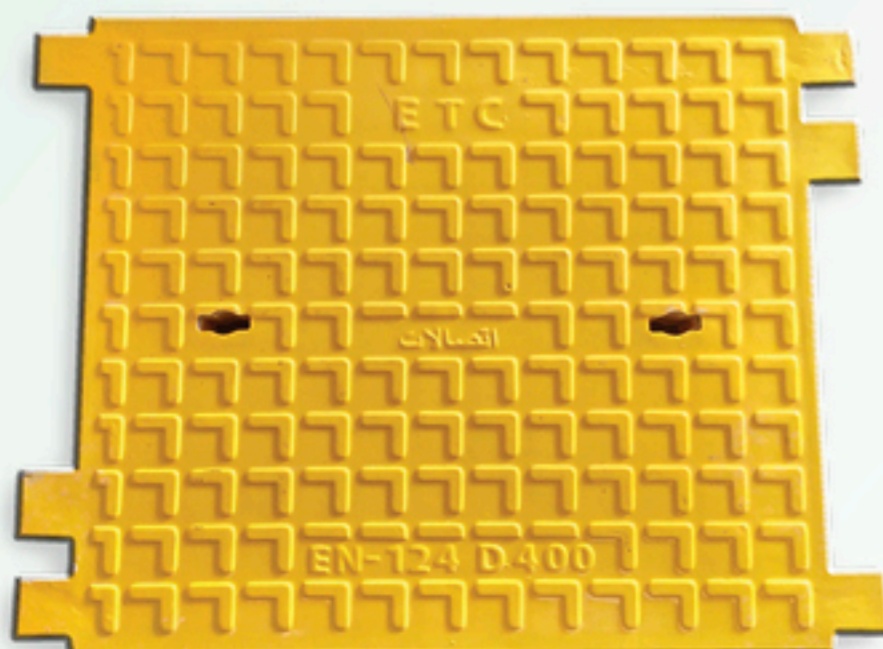

Product code	: TETRON D7060
Available classes	: D400
Clear opening (mm)	: 695 x 609
Frame size (end to end)	: NA
Number of covers	: 1
Frame height	: NA
Hinges (optional)	: NA
Locking (optional)	: NA
Single seal gasket (optional)	: NA
Water tight sealing plate (optional)	: NA

**900 x 445**

## RECTANGULAR TYPE MANHOLE COVER AND FRAME APPROVED BY ETISALAT



Product code	: TEL945 CW4
Available classes	: 15 TONNES
Clear opening (mm)	: 900 x 445
Frame size (end to end)	: 1046 x 641
Number of covers	: 1
Frame Height	: 100
Hinges (optional)	: YES
Locking (optional)	: YES
Single seal gasket (optional)	: NO
Water tight sealing plate (optional)	: YES

**1220 x 696**

## RECTANGULAR TYPE MANHOLE COVER AND FRAME APPROVED BY ETISALAT



Product code	: TEL1269i CW2
Available classes	: D400
Clear opening (mm)	: 1220 x 696
Frame size (end to end)	: 1390 x 890
Number of covers	: 2
Frame height	: 165
Hinges (optional)	: YES
Locking (optional)	: YES
Single seal gasket (optional)	: NO
Water tight sealing plate (optional)	: YES

**1830 x 696**

## RECTANGULAR TYPE MANHOLE COVER AND FRAME APPROVED BY ETISALAT



Product code	: TEL1869j CW3
Available classes	: D400
Clear opening (mm)	: 1830 x 696
Frame size (end to end)	: 2000 x 890
Number of covers	: 3
Frame Height	: 165
Hinges (optional)	: YES
Locking (optional)	: YES
Single seal gasket (optional)	: NO
Water tight sealing plate (optional)	: YES

## DN 600

### CIRCULAR MANHOLE COVER WITH SQUARE FRAME APPROVED BY SHARJAH ELECTRICITY AND WATER AUTHORITY



Product code	: OCTRLON D60
Available classes	: C250, D400
Clear opening (mm)	: 600 DIA
Frame size (end to end)	: 750 x 750
Number of covers	: 1
Frame height	: 120
Hinges (optional)	: NO
Locking (optional)	: YES
Single seal gasket (optional)	: NO
Water tight sealing plate (optional)	: YES

## DN 675

### CIRCULAR MANHOLE COVER WITH SQUARE FRAME APPROVED BY DUBAI ELECTRICITY AND WATER AUTHORITY

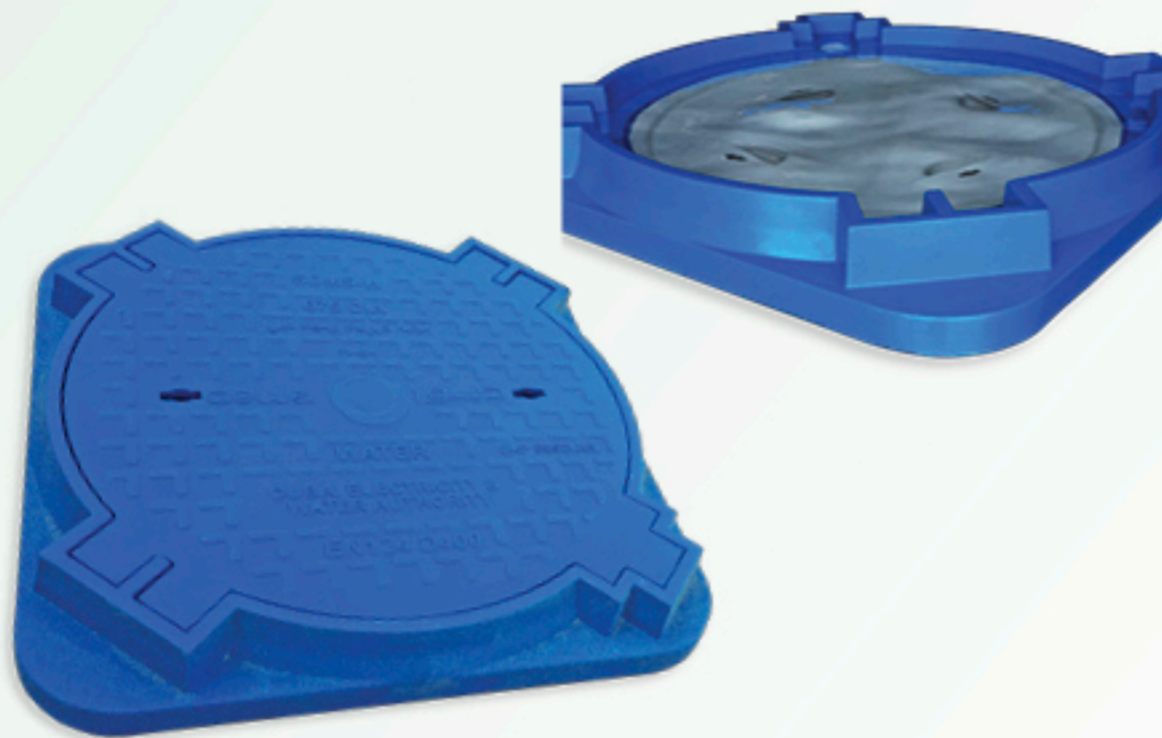

Product code	: OCTRLON D67
Available classes	: D400
Clear opening (mm)	: 675 DIA
Frame size (end to end)	: 845 x 845
Number of covers	: 1
Frame Height	: 100
Hinges (optional)	: NO
Locking (optional)	: YES
Single seal gasket (optional)	: NO
Water tight sealing plate (optional)	: YES

## DN 900

### CIRCULAR MANHOLE COVER WITH SQUARE FRAME APPROVED BY ABUDHABI MUNICIPALITY



Product code	: ORION D90
Available classes	: D400
Clear opening (mm)	: 860 DIA
Frame size (end to end)	: 1160 DIA
Number of covers	: 1
Frame height	: 215
Hinges (optional)	: NO
Locking (optional)	: NO
Single seal gasket (optional)	: NO
Water tight sealing plate (optional)	: NO



**DN 150**

**CIRCULAR MANHOLE COVER WITH SQUARE FRAME  
APPROVED BY DEWA AND SEWA**

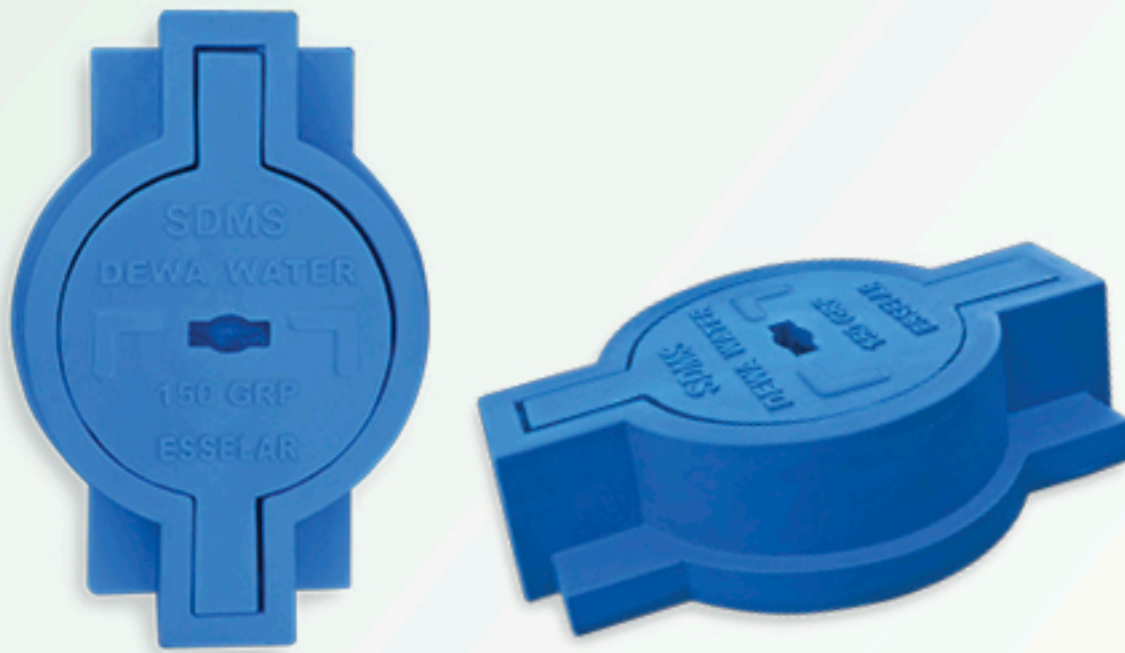

Product code	: <b>ORION C15</b>
Available classes	: D400, C250
Clear opening (mm)	: 150 DIA
Frame size (end to end)	: 400 x 175
Number of covers	: 1
Frame Height	: 100
Hinges (optional)	: NO
Locking (optional)	: YES
Single seal gasket (optional)	: NO
Water tight sealing plate (optional)	: YES

**600 x 600**

**FLUSH INLET GRATING SQUARE MANHOLE COVER AND FRAME**

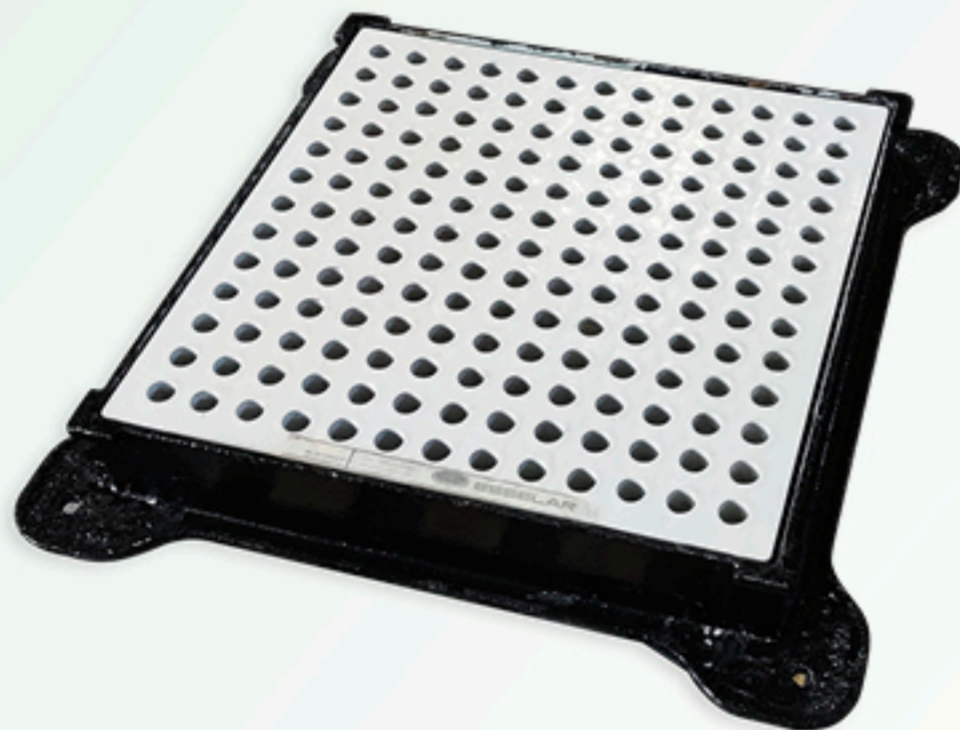

Product code	: <b>QUAD FL60</b>
Available classes	: C250
Cover size (mm)	: 600 x 600
Frame size (end to end)	: 700 x 700
Number of covers	: 1
Frame Height	: 70
Hinges (optional)	: NO
Locking (optional)	: NO
Single seal gasket (optional)	: NO
Water tight sealing plate (optional)	: NO

**900 x 600**

**RECTANGULAR TYPE VACUUM CHAMBER COVER AND FRAME  
APPROVED BY DUBAI MUNICIPALITY**



Product code	: <b>TETRON DB 9060</b>
Available classes	: B 125
Clear opening (mm)	: 900 x 600
Frame size (end to end)	: 1090 x 790
Number of covers	: 1
Frame height	: 70
Hinges (optional)	: NO
Locking (optional)	: YES
Single seal gasket (optional)	: NO
Water tight sealing plate (optional)	: YES

1100 x 600  
900 x 600

**WATER METER FRAME & COVER**  
Approved by Dubai Electricity & Water Authority



Product code	: TETRON B1160i : TETRON B9060i
Available classes	: B125
Clear opening (mm)	: 1100 x 600 : 900 x 600
Number of covers	: 2
Frame height	: 70
Hinges (optional)	: YES
Locking (optional)	: YES
Single seal gasket (optional)	: NO
Water tight sealing plate (optional)	: YES

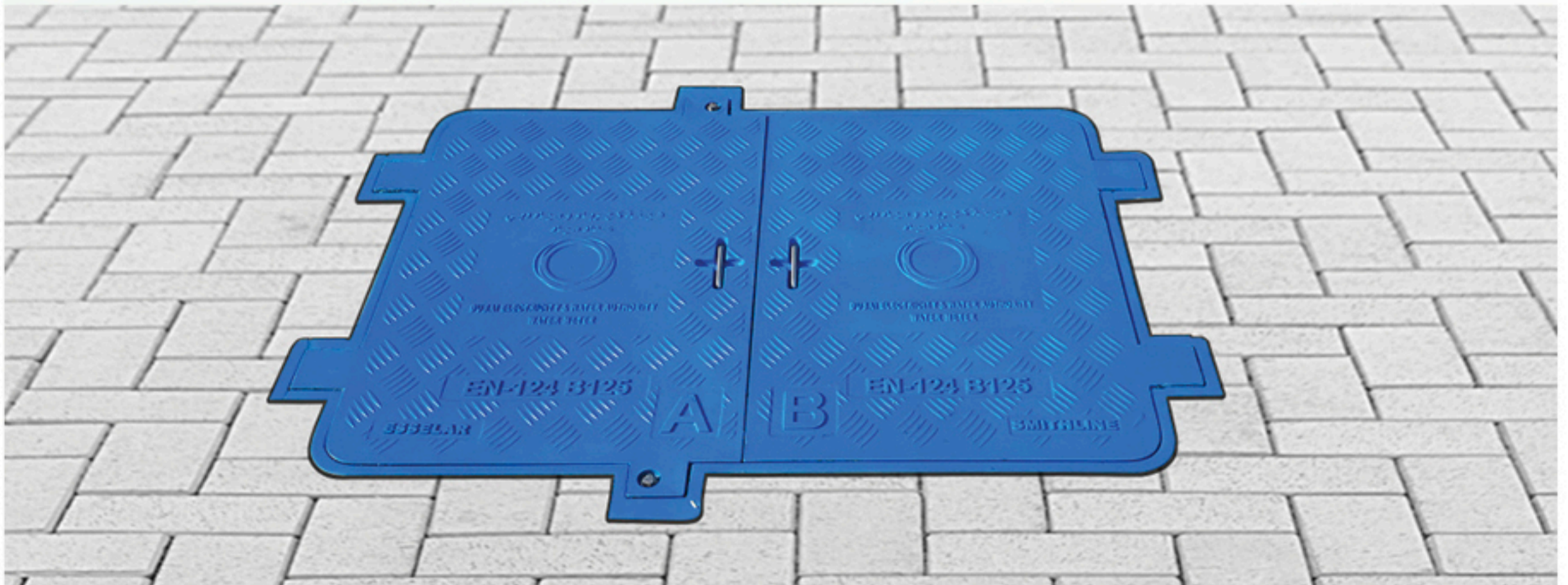

## MANHOLE ACCESSORY - SEALING PLATE WITH EPDM GASKET

ADDITIONAL ACCESSORY FOR LEAK PROOFING MANHOLE COVERS AND FRAMES



# MANHOLE CHAMBERS

Esselar GRP manholes are designed and manufactured as standalone chambers with GRP covers, additional features like hinged & locked covers, with watertight sealing plates and anti-floating.

Anti-floating design is achieved by attaching counter weight with the manhole to balance the buoyancy forces, either by providing flanged bottoms or jacketed shell at bottom area in which concrete mix is added at site as counter weight.

The GRP manholes are designed as standalone and tested as whole chamber to the loading requirements of applicable load class like D400, C250, B125 as per EN124:2015 standard and as per ASTM D3753.

Our GRP manholes are designed in compliance to the specification requirements of Etisalat, ADSSC, ADM and RAKWA. Our design is verified by third party consultants using computerized Finite Element Analysis (FEA) method. Each Design is tested in factory for its full functionality. Our design is most cost effective one in comparing with our competitors.

Smithline Manholes reduces the total installed cost. The installed cost of GRP manholes is around 50% less than the traditional RCC chambers with GRP liners & ductile iron covers.

The end user / project owner gets the below advantages:

- Less project cost
- Installation time is less and thus quick project completion
- Zero maintenance, Corrosion resistance
- Long lasting, more than 50 years of design life
- All-weather resistance.

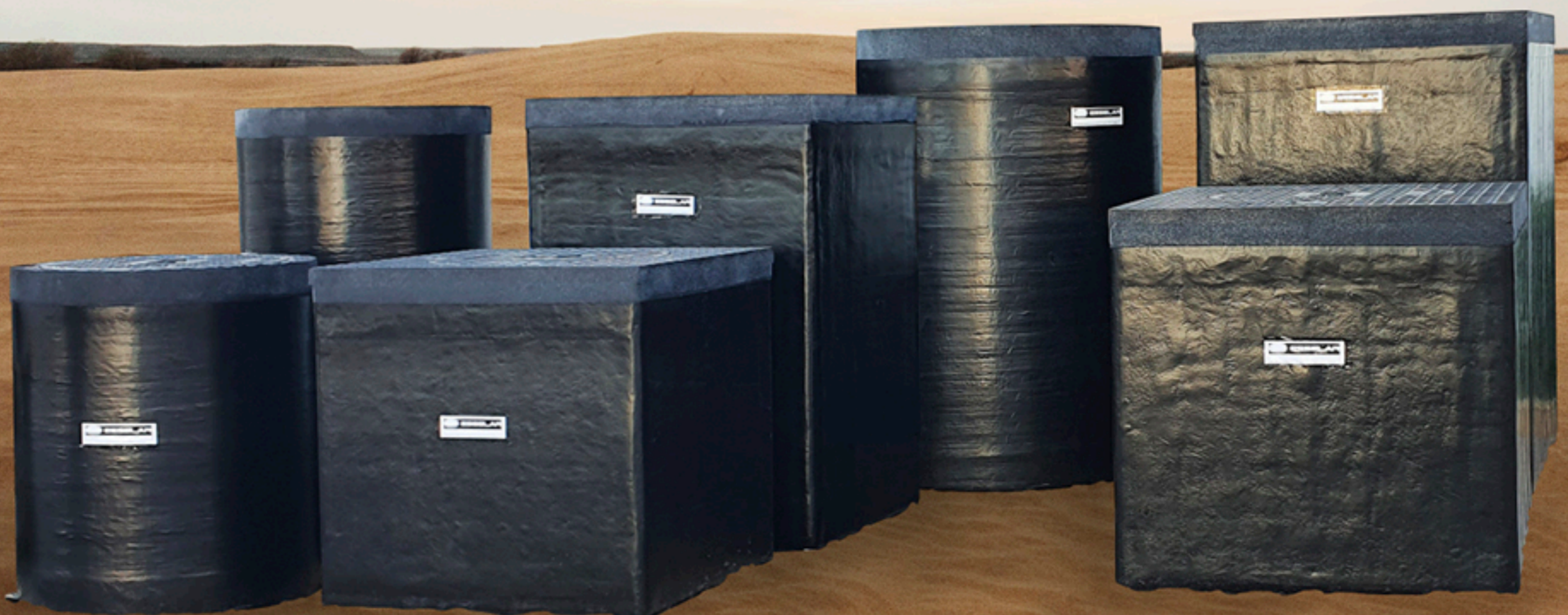

**1000 x 300**

**JOINTBOX  
APPROVED BY ETISALAT**



Product code	: <b>JB 1030 FC</b>
Available classes	: D400
Clear opening (mm)	: 900 x 200
Frame size (end to end)	: 1000 x 300
Number of covers	: 1
Chamber height	: 850
Pipe connections	: Available

**1000 x 400**

**JOINTBOX  
APPROVED BY ETISALAT**



Product code	: <b>JB 1040 FC</b>
Available classes	: D400
Clear opening (mm)	: 900 x 300
Frame size (end to end)	: 1000 x 400
Number of covers	: 1
Chamber height	: 850
Pipe connections	: Available

**1000 x 600**

**JOINTBOX  
APPROVED BY ETISALAT**



Product code	: <b>JB 1060 FC</b>
Available classes	: D400
Clear opening (mm)	: 900 x 500
Frame size (end to end)	: 1000 x 600
Number of covers	: 1
Chamber height	: 850
Pipe connections	: Available

## DN2000

STORM WATER PIT  
APPROVED BY EGA, DUBAI.

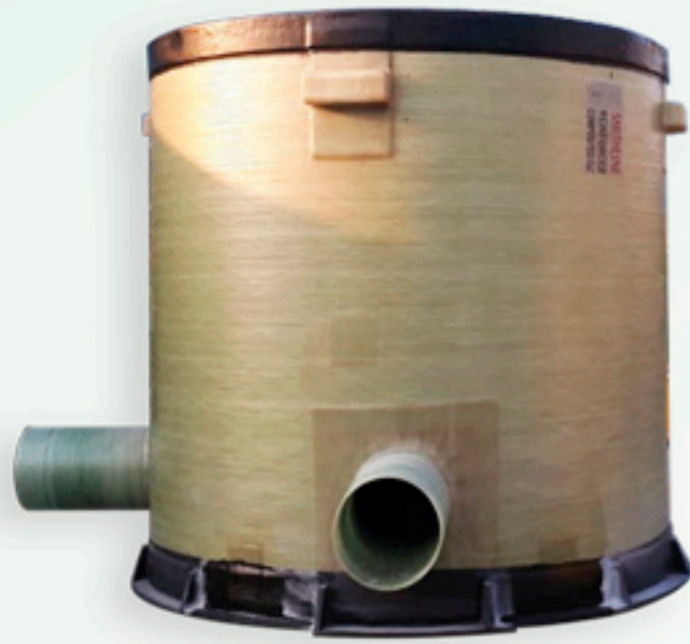

Product code	: SWC 2000
Available classes	: D 400
Clear opening(mm)	: DN 1000
Chamber size (outer)	: DN 2000
Number of covers	: 1
Chamber Height	: Variable
Benching	: Available
Pipe connections	: Optional



## DN1000

STORM WATER PIT  
APPROVED BY RAKWA, RAS AL KHAIMAH



Product code	: SWC 1000
Available classes	: D 400
Clear opening (mm)	: DN 600
Chamber size (outer)	: DN 1000
Number of covers	: 1
Chamber height	: Variable
Benching	: Available
Pipe connections	: Optional

## EUROBALIS BOX

WATER TIGHT BOX SUITABLE FOR INSTALLING SENSORS

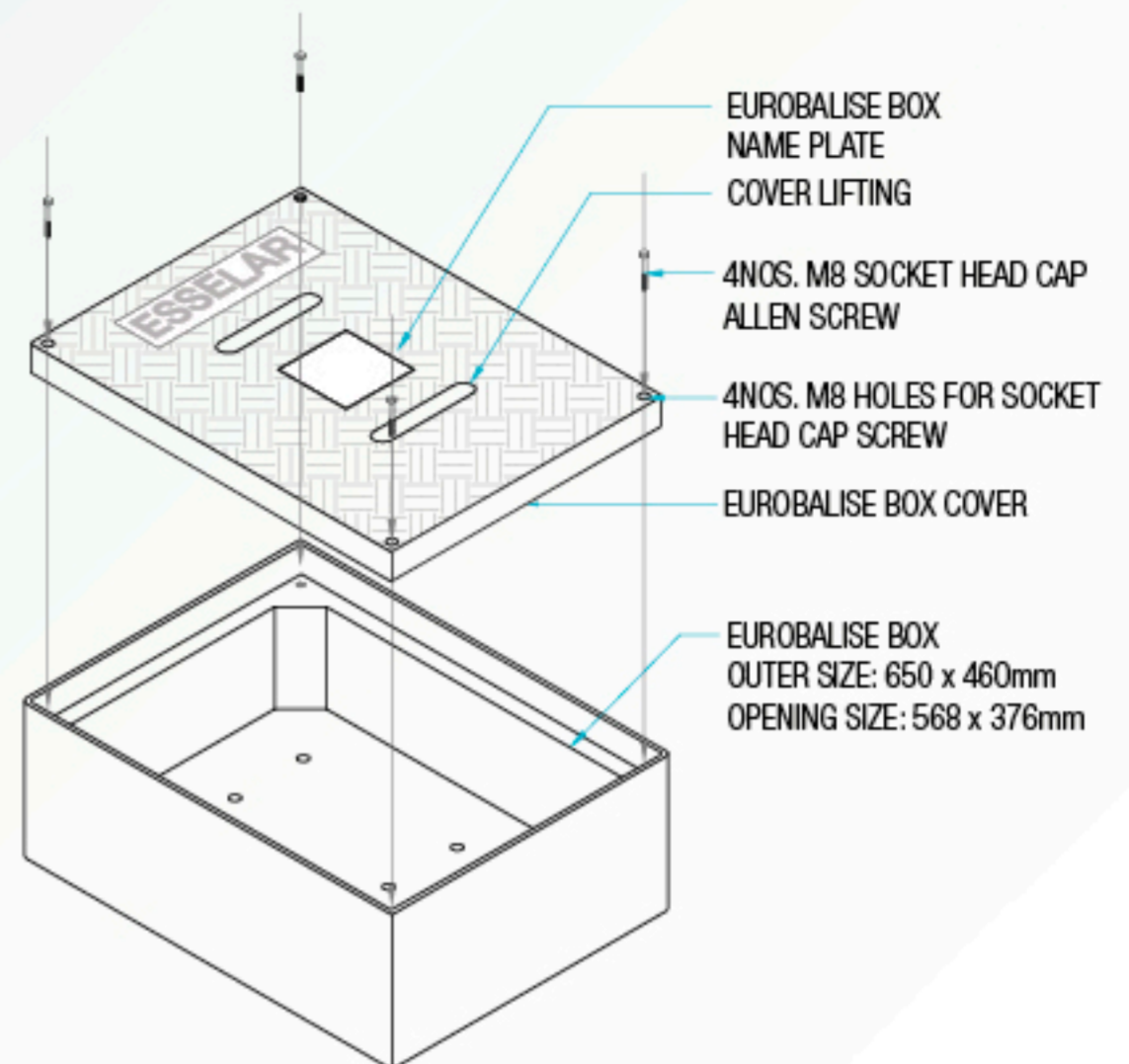

Frame	Legs to prevent rattling & rotation	Hinges	Lockable	Leak proof Gasket	Option for Sealing Plate	Sealing Plate available
Yes	Yes	No	No	No	No	No

## STRAY CURRENT PIT

WATER TIGHT STRAY CURRENT PIT WITH OPEN BASE

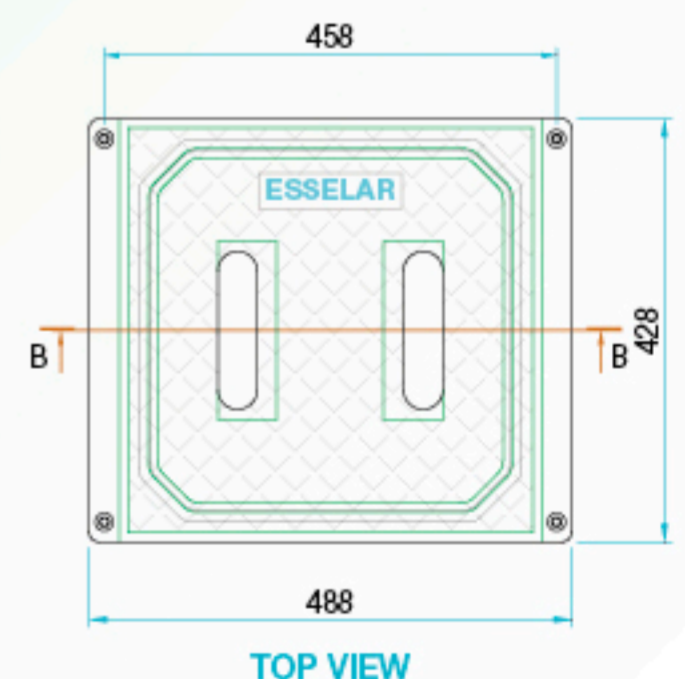
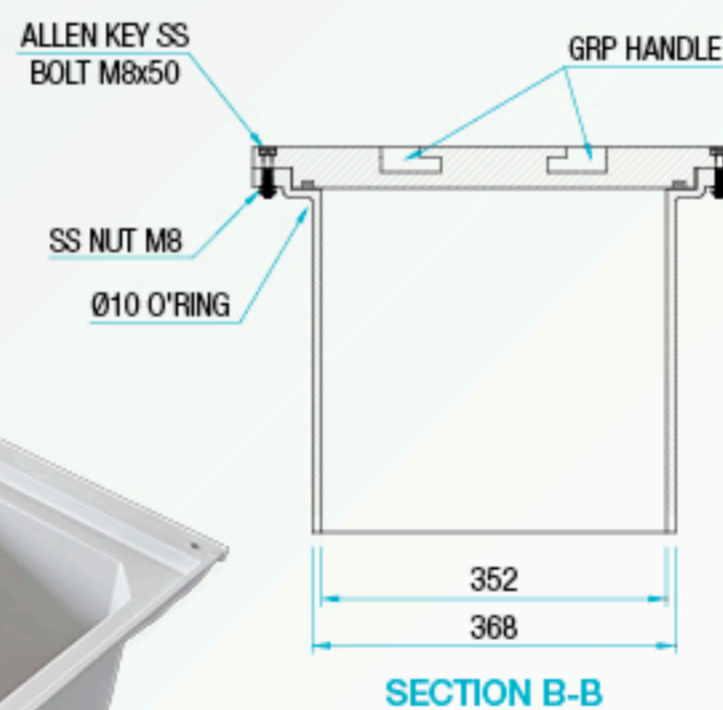

Frame	Legs to prevent rattling & rotation	Hinges	Lockable	Leak proof Gasket	Option for Sealing Plate	Sealing Plate available
Yes	No	No	Yes	Yes	No	No

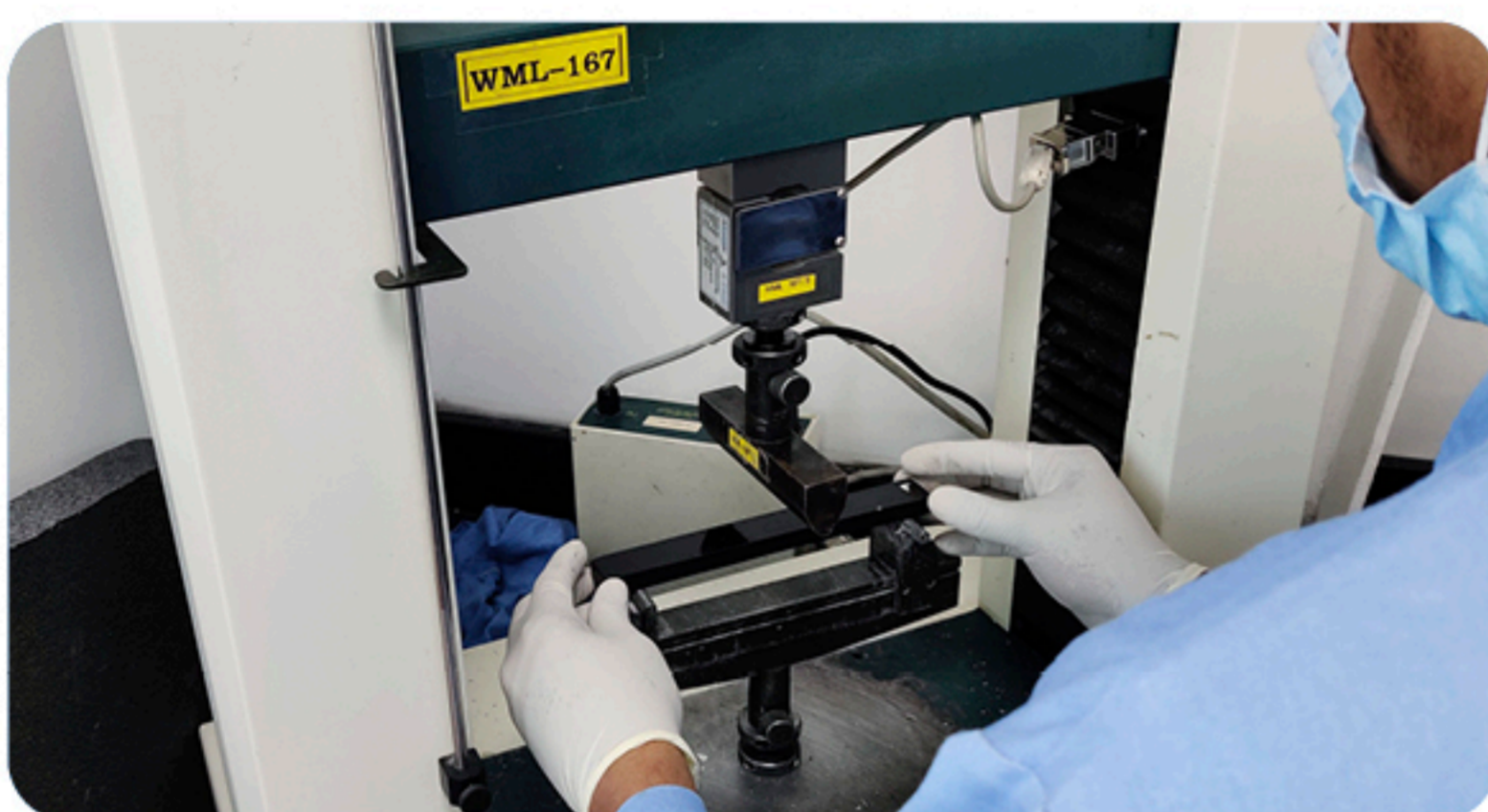
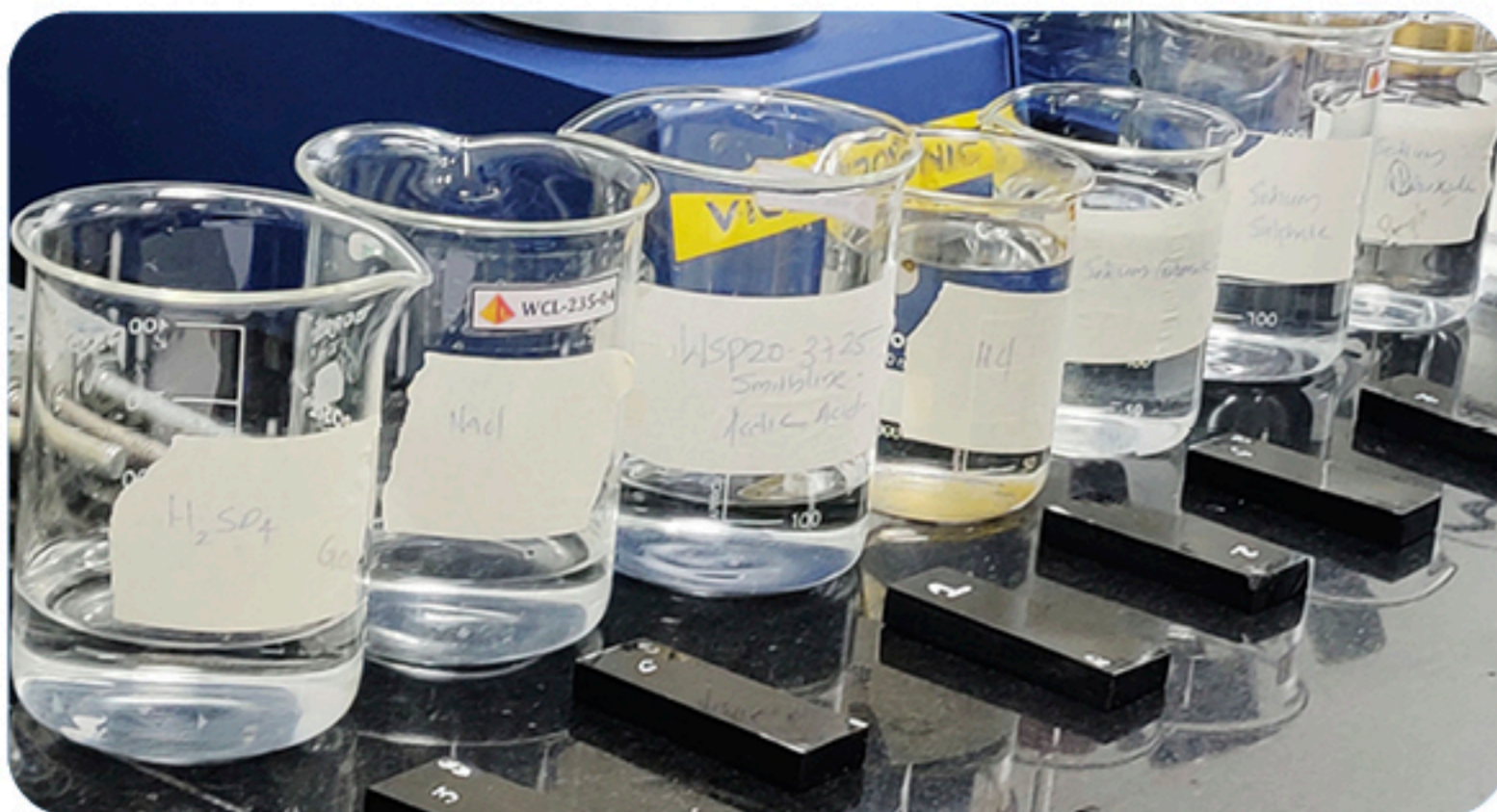

SL #	TEST	LOCATION	TEST METHOD	REPORT NO	RESULT
<b>1</b>	<b>Load Test</b>				
1.1	Load test on Pre-fabricated Chamber with a load of 400KN 1.1000 x 1000x1000 mm depth 2. DN 800 x 1000 mm depth 3.1000 x 800 x 1000 mm depth 4. DN 1000x1500 mm depth 5.1000 x 1000 x 1500mm depth 6. DN 800 x 1500 mm depth 7.1000 x 800 x1500 mm depth	SMITHLINE FACTORY WITH SGS THIRD PARTY WITNESS	BS EN 124: 2015	INDIV-DXB/7650-01	Passed load test as per BS EN 124: 2015 (Class D-400)
1.2	Load test on Pre-fabricated Chamber with a load of 400KN 1. DN 1000 x 1000 mm depth 2.1200 x 1000 x 1000 mm depth 3.1200 x 1000 x 1500 mm depth 4.1200 x 800 x 1000mm depth 5.1200 x 800 x 1500mm depth	SMITHLINE FACTORY WITH SGS THIRD PARTY WITNESS	BS EN 124: 2015	INDIV-DXB/7761-01	Passed load test as per BS EN 124: 2015 (Class D-400)
<b>2</b>	<b>Load Test</b>				
2.1	Load Test as per BS EN 124 for Frame and Covers CW 1	AL HOTY DUBAI	BS EN 124: 2015	D21-399045-1	Conforms to the requirements of BS EN 124: 2015 for load test(400 kN)
2.2	Load Test as per BS EN 124 for Frame and Covers CW 4	AL HOTY DUBAI	BS EN 124: 2015	D21-399046-1	Conforms to the requirements of BS EN 124: 2015 for load test(150 kN)
2.3	Load Test as per BS EN 124 for Frame and Covers CW 2	GEOSCIENCE LAB	BS EN 124-1: 2015 Annex A & B / BS EN 124-5 : 2015	R1DX21-039983	Tested specimen meets the requirements of BS EN 124-1 : 2015 Class D-400 for the load test
2.4	Load Test as per BS EN 124 for Frame and Covers CW 3	GEOSCIENCE LAB	BS EN 124-1: 2015 Annex A & B / BS EN 124-5: 2015	R1DX21-039984	Tested specimen meets the requirements of BS EN 124-1 : 2015 Class D-400 for the load test
2.5	Load Test as per BS EN 124 and other relevant tests for Frame and Covers supplied to Abudhabi Municipality	INDEPENDENT LABORATORIES	BS EN 124-1: 2015	ISTL-280421-059 /01	Tested specimen meets the requirements of BS EN 124-1 : 2015 Class D-400 for the load test
<b>3</b>	<b>Mechanical Properties</b>				
3.1	Tensile Strength	WIMPEY LAB, DUBAI	ASTM D638-14	WLRP20-3725/3	126 Mpa
3.2	Tensile Modulus	WIMPEY LAB, DUBAI	ASTM D638-14	WLRP20-3725/3	8690.2 Mpa
3.3	Percentage Elongation at break	WIMPEY LAB, DUBAI	ASTM D638-14	WLRP20-3725/3	8.71%
3.4	Flexural Strength	WIMPEY LAB, DUBAI	ASTM D790-17	WLRP20-3725/2	243 Mpa
3.5	Flexural Modulus	WIMPEY LAB, DUBAI	ASTM D790-17	WLRP20-3725/2	8890 Mpa
3.6	Imapct Strength	WIMPEY LAB, ABU DHABI	ASTM D256-10 (Method A)	WLRP20-3725/11	4704.77 J/m (no break)
<b>4</b>	<b>Thermal Properties</b>				
4.1	Thermal conductivity( K-Factor) @23°C	WIMPEY LAB, DUBAI	ASTM C518-2010	WLRP20-3725/4	0.1536 W/mK
4.2	Thermal conductivity( K-Factor) @60°C	WIMPEY LAB, DUBAI	ASTM C518-2010	WLRP20-3725/8	0.1684 W/mK
4.3	Temperature Resistance - [-40°C]	WIMPEY LAB, DUBAI	ASTM D2485-18	WLRP20-3725/1	No surface failure or damages were observed at [-40°C]
4.4	Temperature Resistance - [+80°C]	WIMPEY LAB, DUBAI	ASTM D2485-18	WLRP20-3725/1	No surface failure or damages were observed at [+80°C]
4.5	Vicat Softening Temperature (VST)(B120)	WIMPEY LAB, ABU DHABI	ASTM D1525-17e1	WLRP20-3525/10	No deformation observed at 160°C test temperature.



5 Chemical Resistance (change in dimension)					
5.1	Resistance to Acetic Acid	WIMPEY LAB, DUBAI	ASTM D543-20	WLRP20-3725/6	No significant changes in dimensions observed
5.2	Resistance to Hydrochloric Acid	WIMPEY LAB, DUBAI	ASTM D543-20	WLRP20-3725/6	No significant changes in dimensions observed
5.3	Resistance to Sulphuric Acid	WIMPEY LAB, DUBAI	ASTM D543-20	WLRP20-3725/6	No significant changes in dimensions observed
5.4	Resistance to Sodium Carbonate	WIMPEY LAB, DUBAI	ASTM D543-20	WLRP20-3725/6	No significant changes in dimensions observed
5.5	Resistance to Calcium Carbonate	WIMPEY LAB, DUBAI	ASTM D543-20	WLRP20-3725/6	No significant changes in dimensions observed
5.6	Resistance to Sodium Chloride	WIMPEY LAB, DUBAI	ASTM D543-20	WLRP20-3725/6	No significant changes in dimensions observed
5.7	Resistance to Sodium Sulphate	WIMPEY LAB, DUBAI	ASTM D543-20	WLRP20-3725/6	No significant changes in dimensions observed
5.8	Resistance to Sodium Hydroxide	WIMPEY LAB, DUBAI	ASTM D543-20	WLRP20-3725/6	No significant changes in dimensions observed
5.9	Resistance to oils and greases	WIMPEY LAB, DUBAI	ASTM D543-20	WLRP20-3725/6	No significant changes in dimensions observed
6 Chemical Resistance (Flexural strength after immersion)					
6.1	Before Immersion (refer 3.2)	WIMPEY LAB, DUBAI	ASTM D790-17	WLRP20-3725/2	243 Mpa
6.2	Acetic Acid	WIMPEY LAB, DUBAI	ASTM D790-17	WLRP20-3725/7	259 Mpa
6.3	Hydrochloric Acid	WIMPEY LAB, DUBAI	ASTM D790-17	WLRP20-3725/7	229 Mpa
6.4	Sulphuric Acid	WIMPEY LAB, DUBAI	ASTM D790-17	WLRP20-3725/7	241 Mpa
6.5	Sodium Carbonate	WIMPEY LAB, DUBAI	ASTM D790-17	WLRP20-3725/7	248 Mpa
6.6	Calcium Carbonate	WIMPEY LAB, DUBAI	ASTM D790-17	WLRP20-3725/7	229 Mpa
6.7	Sodium Chloride	WIMPEY LAB, DUBAI	ASTM D790-17	WLRP20-3725/7	234 Mpa
6.8	Sodium Sulphate	WIMPEY LAB, DUBAI	ASTM D790-17	WLRP20-3725/7	249 Mpa
6.9	Sodium Hydroxide	WIMPEY LAB, DUBAI	ASTM D790-17	WLRP20-3725/7	238 Mpa
6.10	Oils and greases	WIMPEY LAB, DUBAI	ASTM D790-17	WLRP20-3725/7	238 Mpa
7 Water Absorption					
7	Water Absorption	WIMPEY LAB, DUBAI	ASTM D570-18	WLRP20-3725/5	0.0004
8 Weathering Resistance					
8	Weathering Resistance	WIMPEY LAB, DUBAI	ASTM G154-16	WLRP20-3725/9	No cracking, no chalking, no flaking, no wrinkling, no blistering or any other type of failure observed
9 Corrosion resistance test on SS Rod used in hinges					
9	Corrosion resistance test on SS Rod used in hinges	WIMPEY LAB, DUBAI	ASTM B117-18	WD-R-210701-0378/2	No cracking, no flaking, no blistering, no spot rusting was observed
10 Corrosion resistance test on SS bolts used for locking					
10	Corrosion resistance test on SS bolts used for locking	WIMPEY LAB, DUBAI	ASTM B117-18	WD-R-210701-0378/1	No cracking, no flaking, no blistering, no spot rusting was observed
11 Chemical analysis on SS bolt used for locking					
11	Chemical analysis on SS bolt used for locking	WIMPEY LAB, DUBAI	ASTM A751/XRF	WD-R-210701-0377/1	The tested samples confirms to the grade SS 316
12 Chemical analysis on SS rod used in hinges					
12	Chemical analysis on SS rod used in hinges	WIMPEY LAB, DUBAI	ASTM A751/XRF	WD-R-210701-0377/2	The tested samples confirms to the grade SS 316



Scan the QR code for test reports

## BRIDGE ACCESS COVERS

## ACCESS COVER UNDER BRIDGES

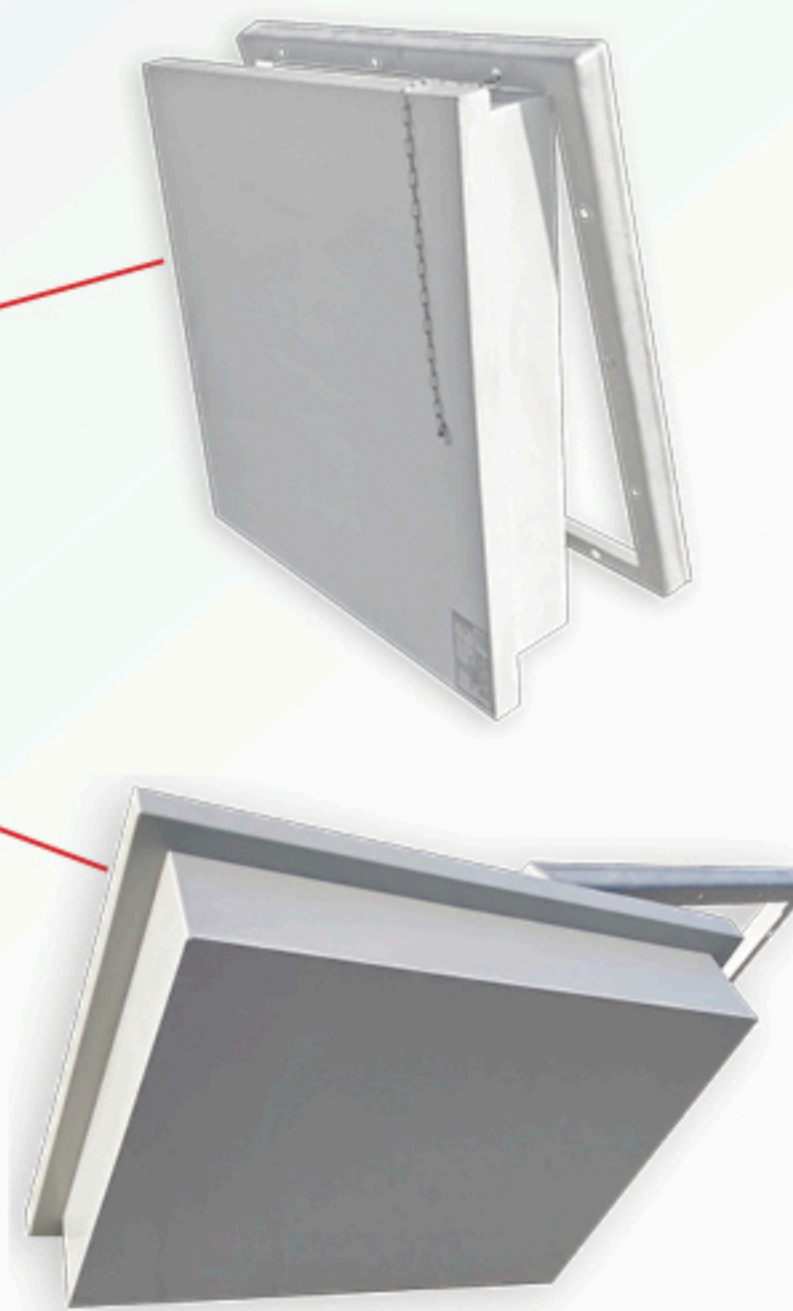
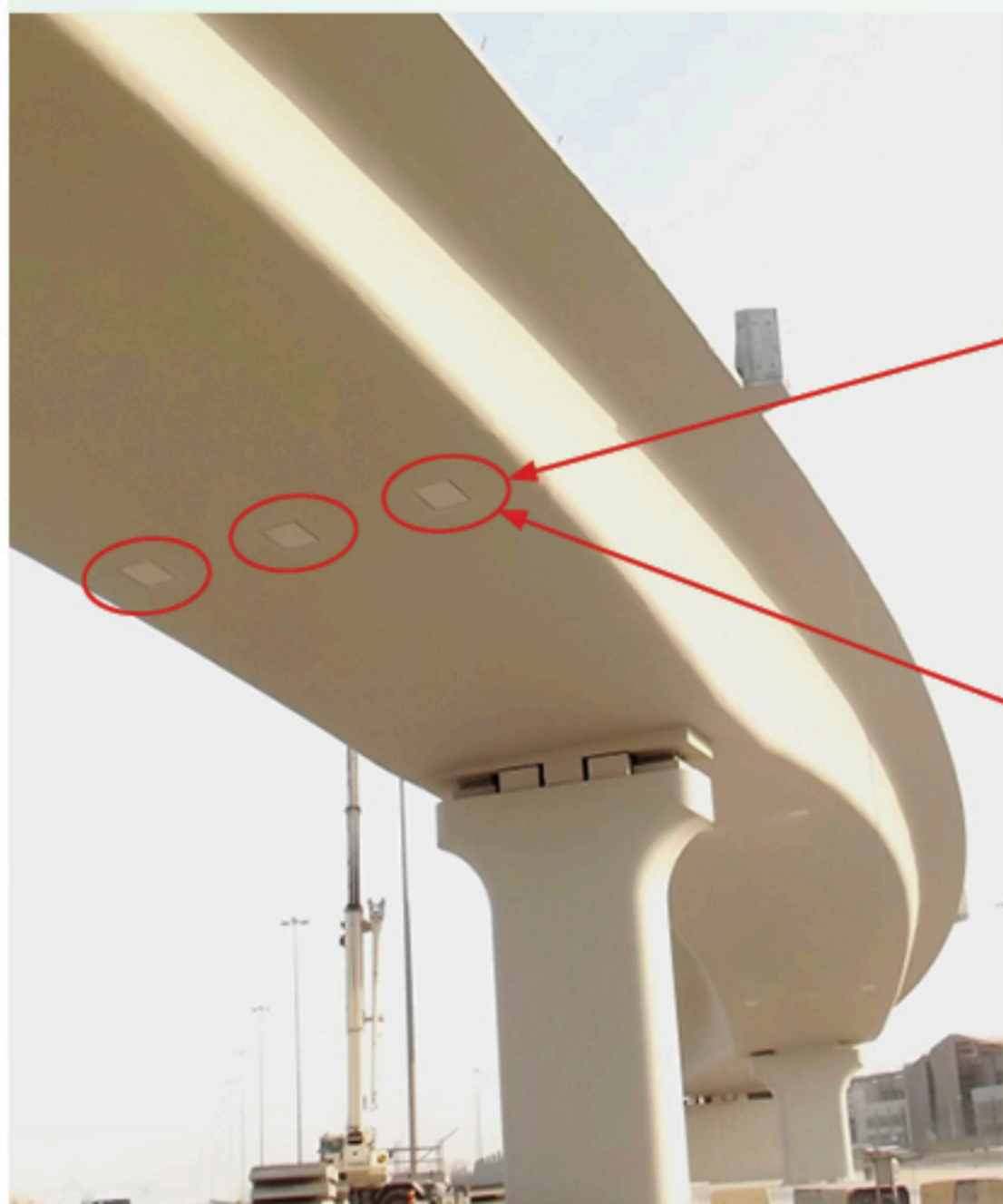

## OTHER MAJOR PRODUCTS FROM SMITHLINE

# FOAM DIVISION

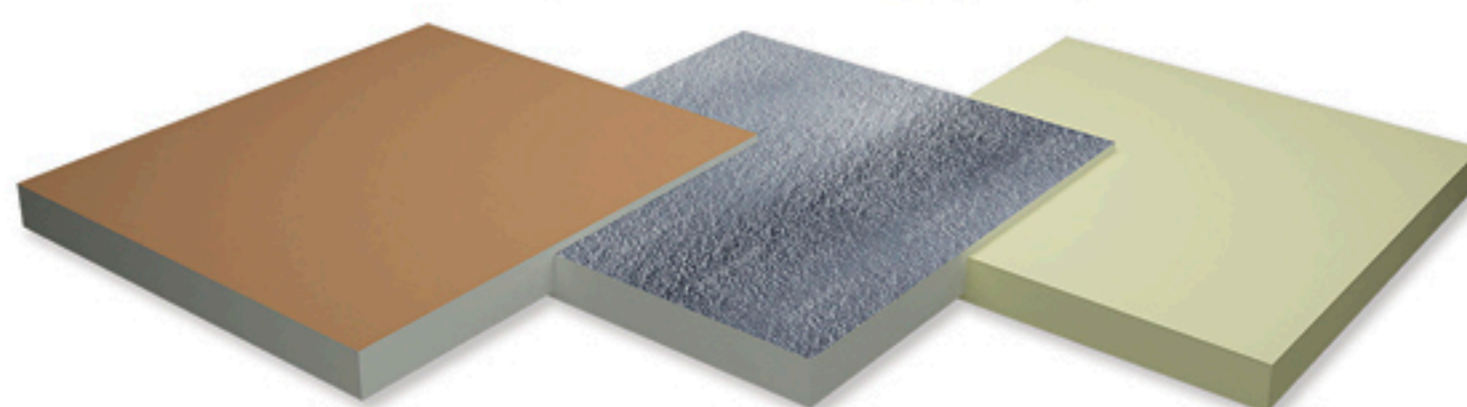
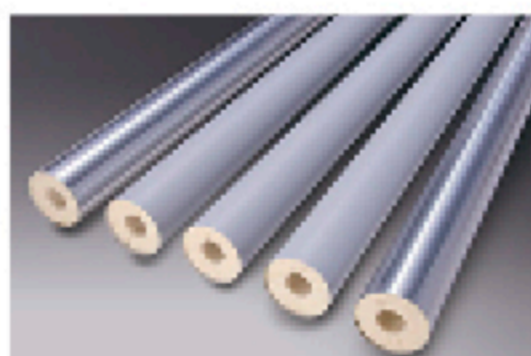
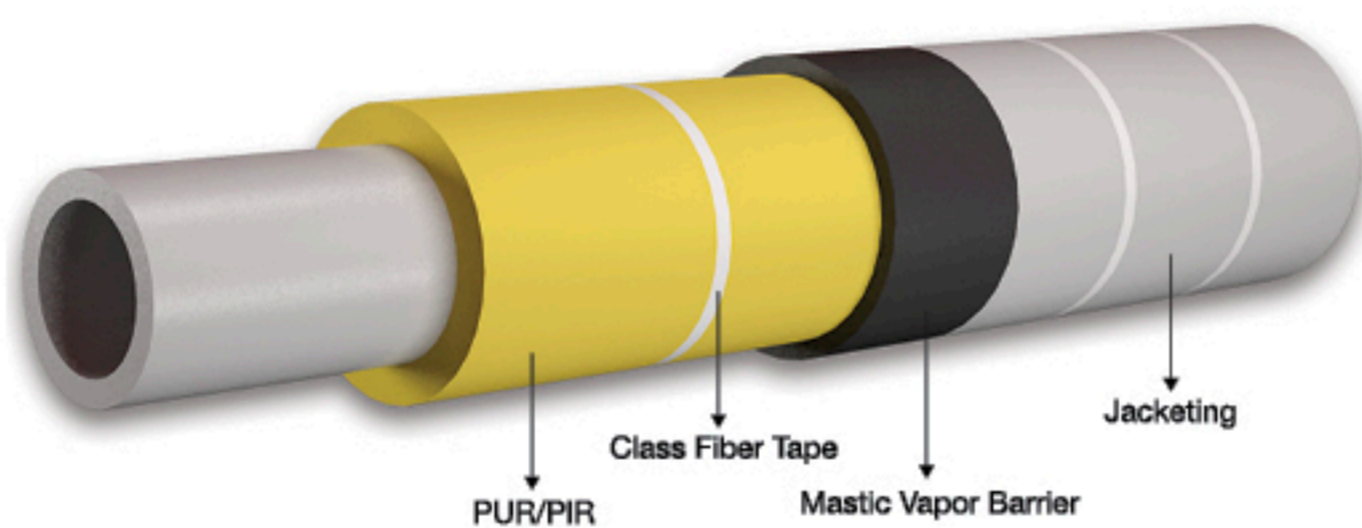

# PIPES, FITTINGS & SPECIALS

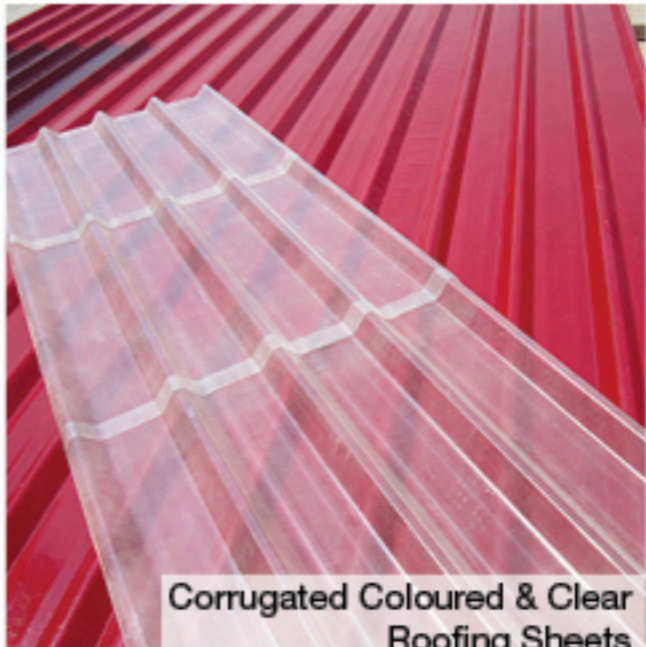
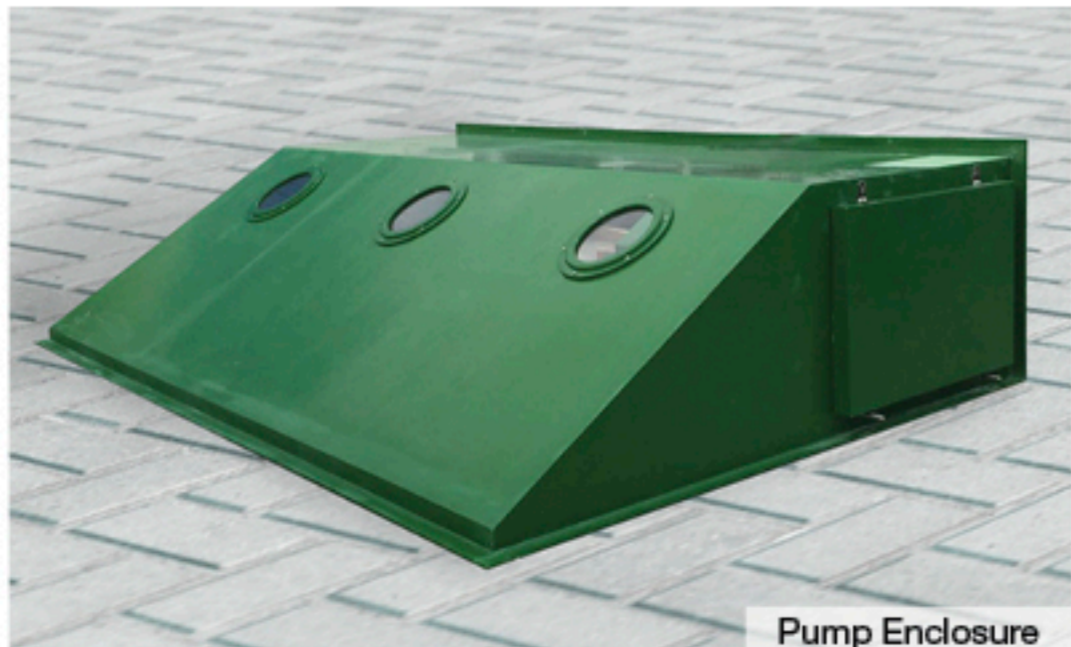
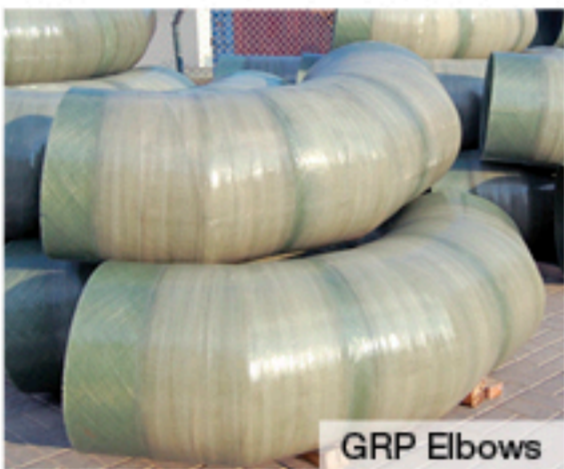
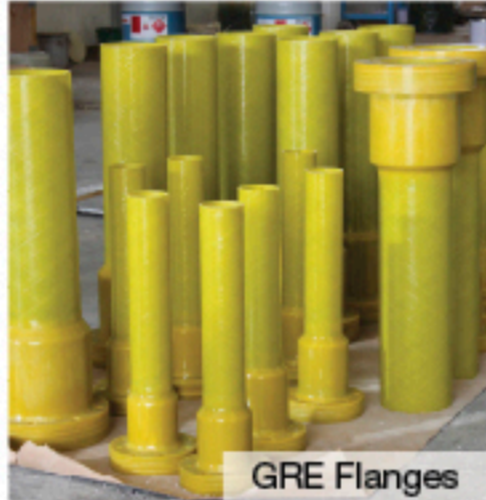
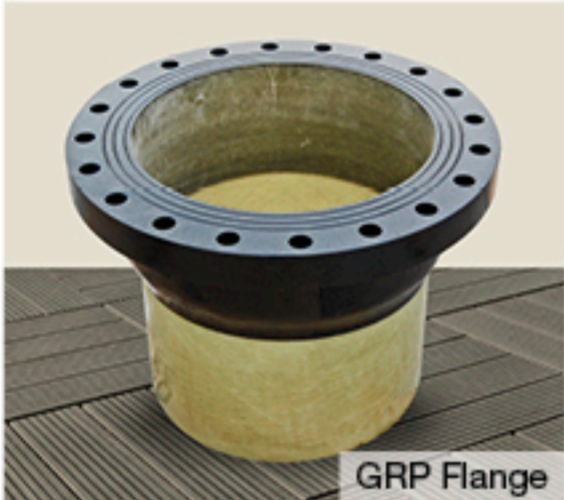
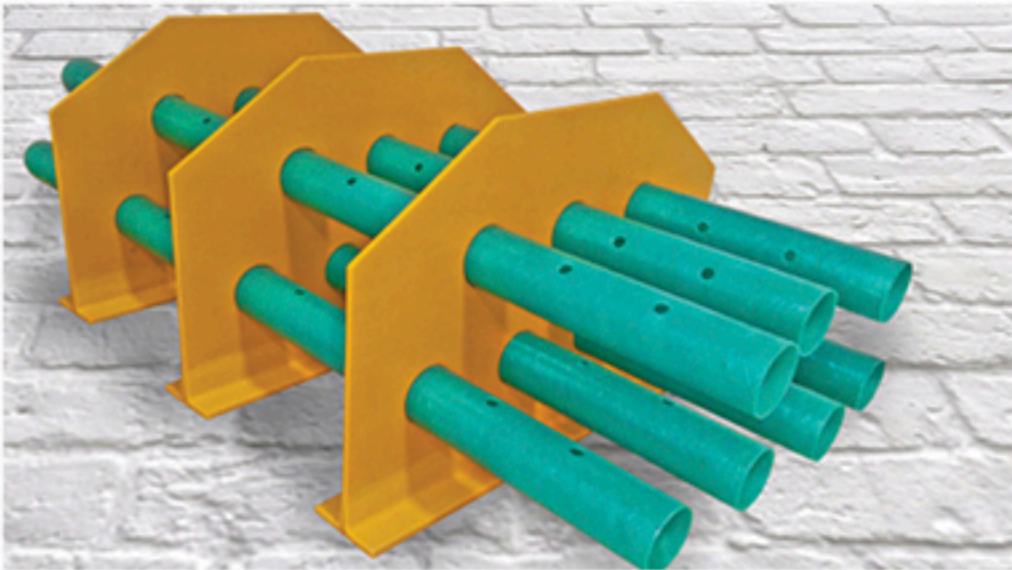



**Smithline Reinforced Composites FZ-LLC**

P.O.Box 6523, RAK Investment Authority, RAK, U.A.E  
 Tel: +971-72434947, Fax: +971-72434946, E-mail: info@smithlinecomposites.com  
[www.smithlinecomposites.com](http://www.smithlinecomposites.com)  
[www.esselarcomposites.com](http://www.esselarcomposites.com)



An ISO 9001:2015 certified company



GRP-1706505  
 GRV-1706506, GRE-1706510



KM 670931



API 15HR-15HR-0102  
 API 15LR-15LR-0103

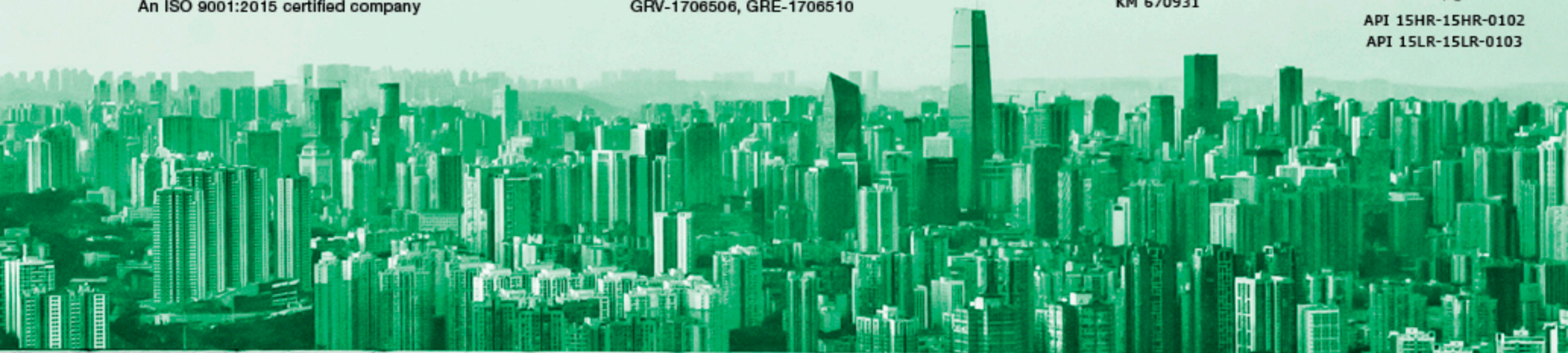

**ESSELAR**

